

**Miniature Broadband Gain Stage
70 - 3000 MHz**

**MAALSS0038
V1**

Features

- Low Noise Figure
- High IP₃
- Single +3 V or +5 V Supply Voltage
- Little performance change over Temperature
- Lead-Free SC-70 6-Lead (SOT-363) Package
- 100% Matte Tin Plating over Copper
- Halogen-Free “Green” Mold Compound
- 260°C Reflow Compatible
- RoHS* Compliant Version of MAALSS0012

Description

M/A-COM’s MAALSS0038 broadband gain stage is a GaAs MMIC amplifier in a lead-free SOT-363 surface mount plastic package. The MAALSS0038 employs a monolithic 1-stage self-biased design featuring a convenient 50 ohm input/output impedance that minimizes the number of external components required. The device typically runs from a single 3.0 volt supply and may also operate at any voltage up to 5.0 volts for improved power performance. Its broadband design provides usable performance from 70 to 3000 MHz. To show off-chip tuning requirements from 70 to 210 MHz, IF application circuitry is available on page 6.

M/A-COM fabricates the MAALSS0038 using an E/D MESFET process to realize low noise and high dynamic range. The process features full passivation for performance and reliability.

Ordering Information

Part Number	Package
MAALSS0038	Bulk Packaging
MAALSS0038TR-3000	3000 piece reel
MAALSS0038SMB	Sample Test Board

Note: Reference Application Note M513 for reel size information.

Functional Block Diagram

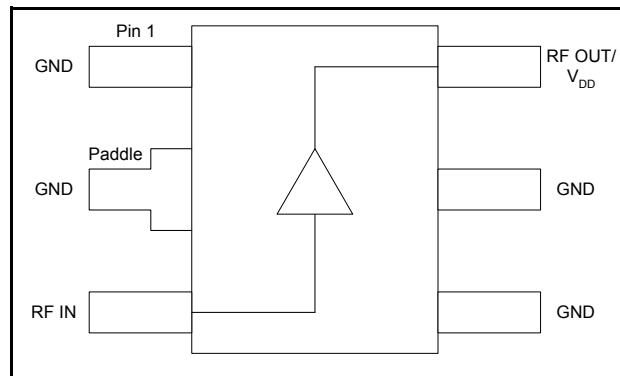

PIN Configuration

PIN	Function	Description
1	GND	Ground
2	GND	Ground
3	RF In	RF input
4	GND	Ground
5	GND	Ground
6 ¹	RF Out/V _{DD}	RF output & drain voltage input

1. Series inductor and decoupling capacitor recommended on pin 6.

Absolute Maximum Ratings^{2,3}

Parameter	Absolute Maximum
RF Input Power	15 dBm
Voltage	6.0 volts
Operating Temperature	-40 °C to +85 °C
Storage Temperature	-65 °C to +150 °C

2. Exceeding any one or combination of these limits may cause permanent damage to this device.
3. M/A-COM does not recommend sustained operation near these survivability limits.

* Restrictions on Hazardous Substances, European Union Directive 2002/95/EC.

**Miniature Broadband Gain Stage
70 - 3000 MHz**

**MAALSS0038
V1**

Electrical Specifications: $Z_0 = 50 \Omega$, $T_A = 25^\circ\text{C}$

Parameter	Test Conditions	Units	+5 V		
			Min.	Typ.	Max.
Gain ⁴	F = 0.9 GHz	dB	—	14.2	—
	F = 1.9 GHz	dB	11.0	12.0	13.0
	F = 3.0 GHz	dB	—	9.6	—
Noise Figure ⁵	F = 0.9 GHz	dB	—	1.5	—
	F = 1.9 GHz	dB	—	1.5	2.0
	F = 3.0 GHz	dB	—	1.6	—
Input Return Loss	F = 0.9 GHz	dB	—	9.4	—
	F = 1.9 GHz	dB	—	13.2	—
	F = 3.0 GHz	dB	—	14.7	—
Output Return Loss	F = 0.9 GHz	dB	—	9.7	—
	F = 1.9 GHz	dB	—	15.5	—
	F = 3.0 GHz	dB	—	33.0	—
Output P1dB	200 – 3000 MHz	dBm	—	21	—
Output IP ₃	200 – 3000 MHz	dBm	—	32	—
Current	—	mA	50	87	100

4. Gain varies at -0.0025 dB/°C typical.

5. Noise figure varies at 0.007 dB/°C typical.

Application Schematic

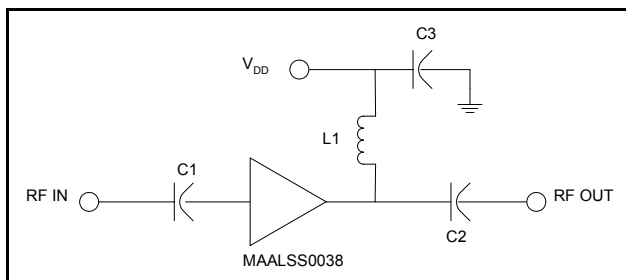

Component List⁶, 200 - 3000 MHz

Part	Value	Case Style	Manufacturer	Purpose
C1	39 pF	0402	Murata	Input DC Block
C2	39 pF	0402	Murata	Output DC Block
C3	470 pF	0402	Murata	RF Bypass
L1	12 nH	0805	Coilcraft	RF Choke/Tuning

6. See page 6 for IF application circuitry.

Recommended PCB Configuration

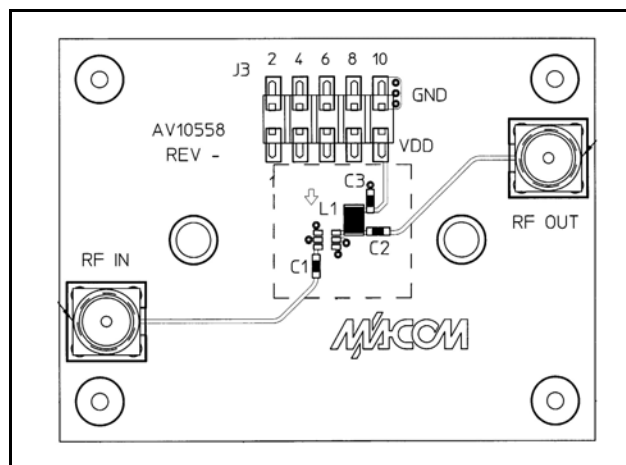

**Miniature Broadband Gain Stage
70 - 3000 MHz**

**MAALSS0038
V1**

Typical Performance Curves

S-Parameters, $V_{DD} = 5.0\text{ V}$, $T = 25\text{ }^\circ\text{C}$

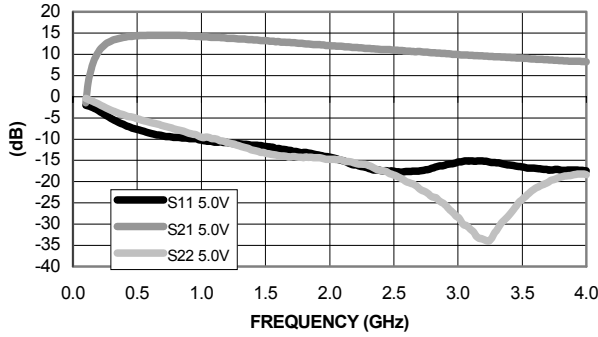

Noise Figure, $V_{DD} = 5.0\text{ Volts}$

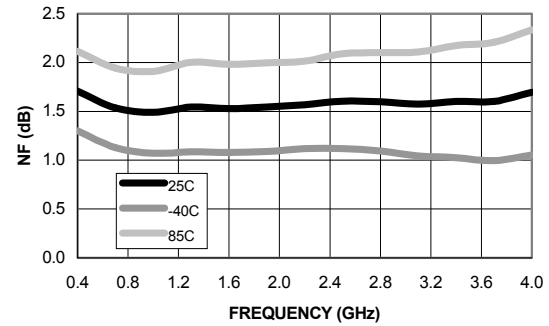

S-Parameters, $V_{DD} = 5.0\text{ V}$, $T = -40\text{ }^\circ\text{C}$

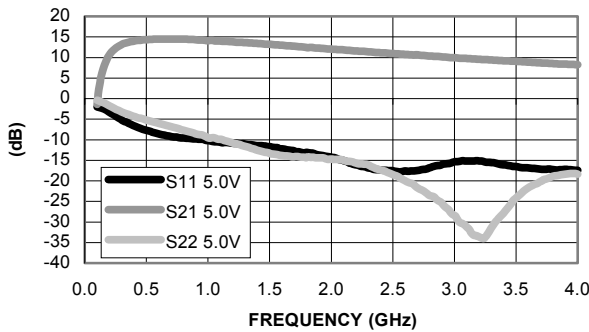

Output P_{1dB} , $V_{DD} = 5.0\text{ Volts}$

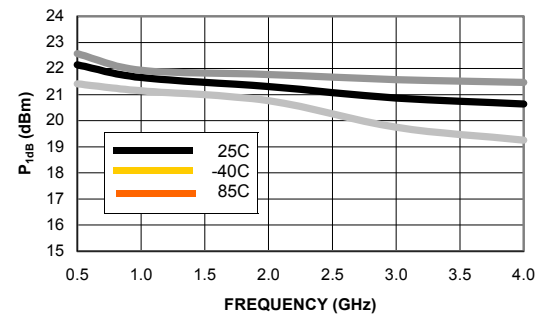

S-Parameters, $V_{DD} = 5.0\text{ V}$, $T = 70\text{ }^\circ\text{C}$

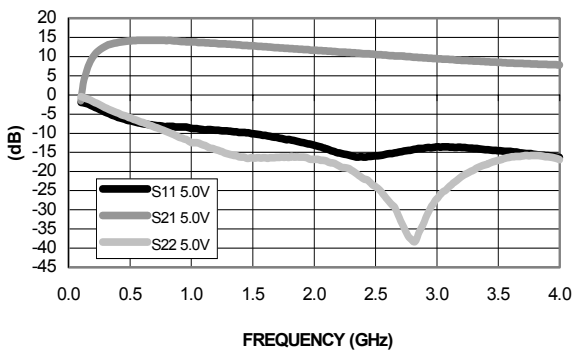

**Miniature Broadband Gain Stage
70 - 3000 MHz**

**MAALSS0038
V1**

Typical Performance Curves (Cont'd)

S-Parameters, $V_{DD} = 3.0\text{ V}$, $T = 25\text{ }^{\circ}\text{C}$

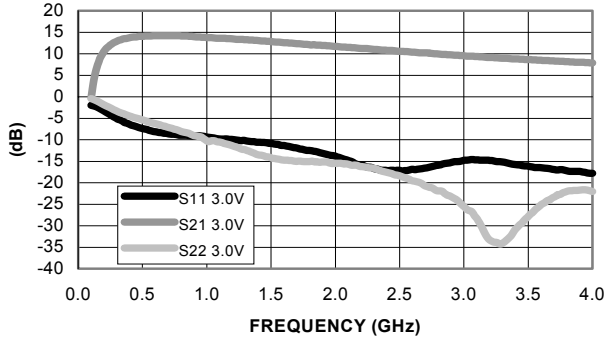

Noise Figure, $V_{DD} = 3.0\text{ Volts}$

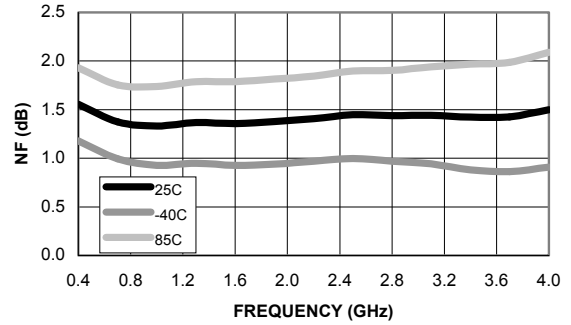

S-Parameters, $V_{DD} = 3.0\text{ V}$, $T = -40\text{ }^{\circ}\text{C}$

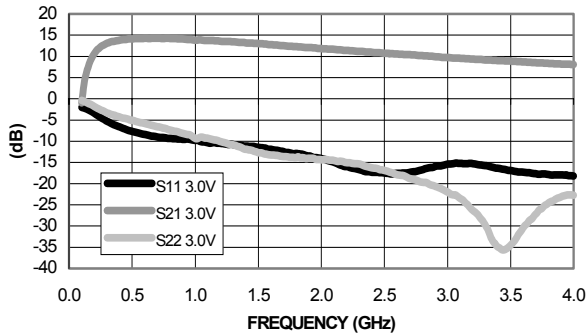

Output P_{1dB} , $V_{DD} = 3.0\text{ Volts}$

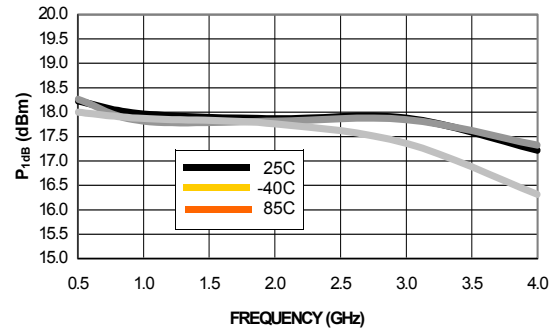

S-Parameters, $V_{DD} = 3.0\text{ V}$, $T = 70\text{ }^{\circ}\text{C}$

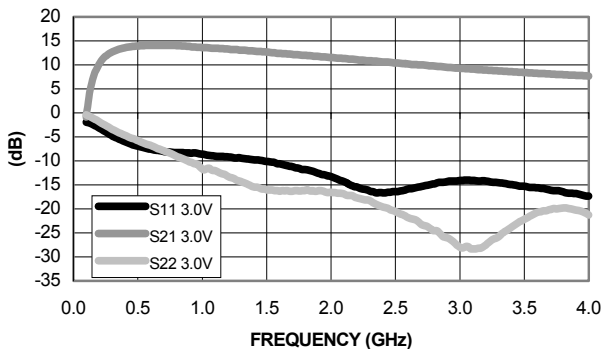

**Miniature Broadband Gain Stage
70 - 3000 MHz**

**MAALSS0038
V1**

Typical Performance Curves (Cont'd)

S-Parameters, $V_{DD} = 2.7\text{ V}$, $T = 25\text{ }^\circ\text{C}$

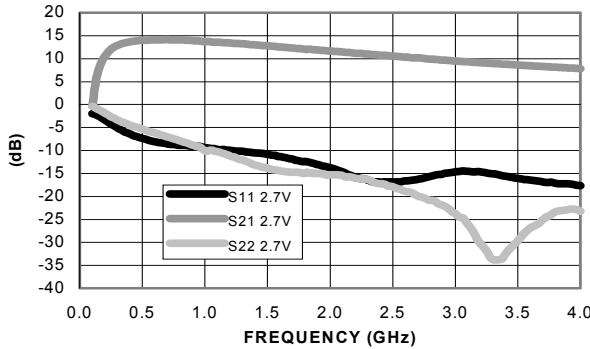

Noise Figure, $V_{DD} = 2.7\text{ Volts}$

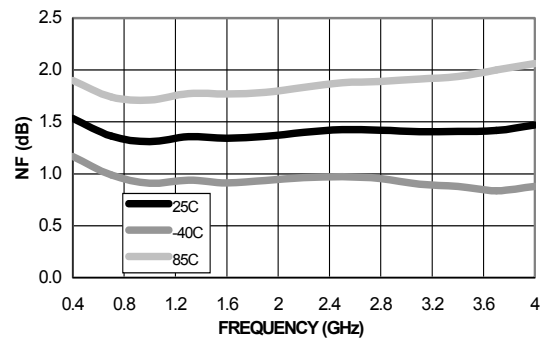

S-Parameters, $V_{DD} = 2.7\text{ V}$, $T = -40\text{ }^\circ\text{C}$

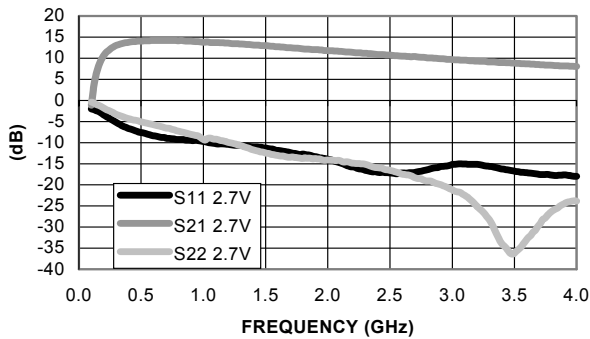

Output P_{1dB} , $V_{DD} = 2.7\text{ Volts}$

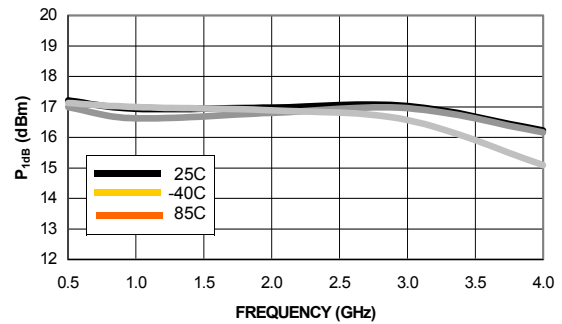

S-Parameters, $V_{DD} = 2.7\text{ V}$, $T = 70\text{ }^\circ\text{C}$

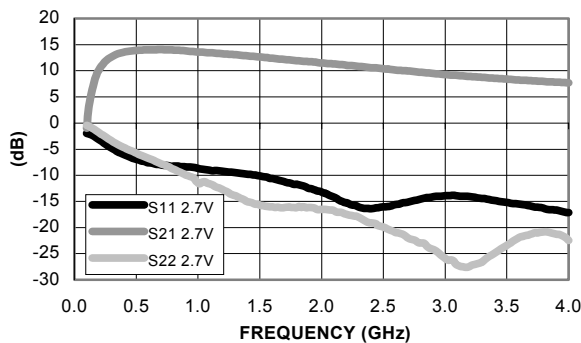

**Miniature Broadband Gain Stage
70 - 3000 MHz**

**MAALSS0038
V1**

IF Application Configuration

Frequency (MHz)						
	71		143		211	
Configuration						
C1, C2, C3	0.1 μ F		0.1 μ F		0.1 μ F	
L1	68 nH		39 nH		39 nH	
L2	220 nH		82 nH		39 nH	
Typical Performance	3V	5V	3V	5V	3V	5V
S11 (dB)	-11	-11	-15	-15	-15	-15
S22 (dB)	-13	-13	-11	-11	-11	-11
S21 (dB)	17	17	16.25	16.25	16	16
S12 (dB)	-25	-25	-25	-25	-25	-25
OIP3 (dBm)	29	30	29	30	26	27
NF (dB)	2.5	2.5	2.5	2.5	2	2

IF Application Functional Block Diagram

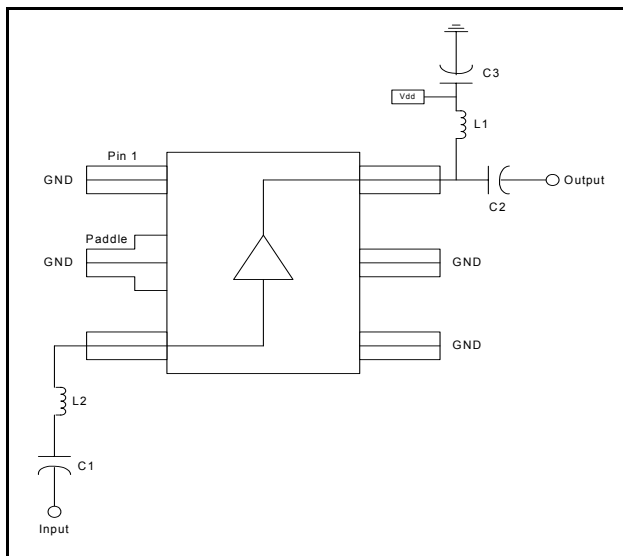

Lead-Free SC-70 6-Lead (SOT-363)[†]

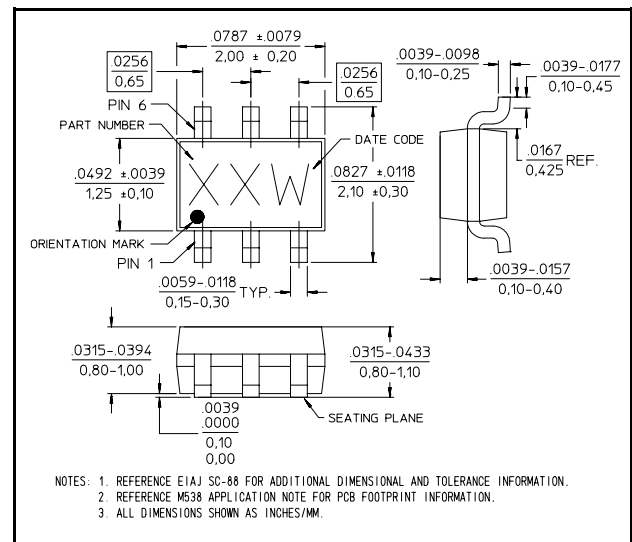

[†] Reference Application Note M538 for lead-free solder reflow recommendations.